

MEDICROSS

Tel: +46 31 28 08 00

Fax: +46 31 81 24 24

1

CERAMO®

MICRO
SURGICAL
INSTRUMENTS

MIKRO-
CHIRURGISCHE
INSTRUMENTE

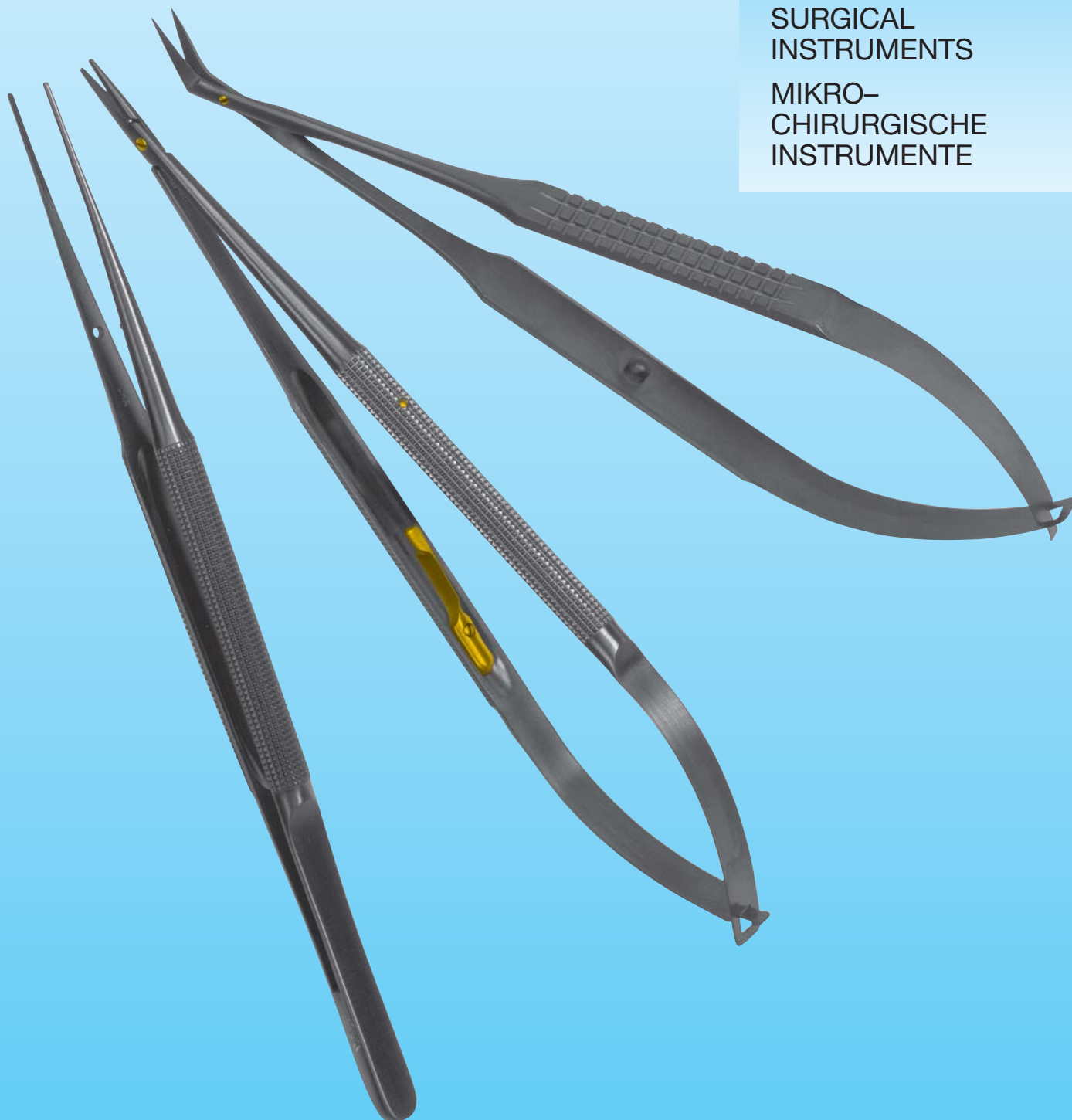







MEDICROSS⁺

CERAMO® RONDO

MICRO FORCEPS
MIKROPINZETTEN







PATTERN MODELL	LENGTH LÄNGE	JAW MAUL	120 mm	150 mm	180 mm	210 mm	230 mm	250 mm
			0,15 mm			COV-6		
	0,3 mm	COV-8	COV-2	COV-4				
	0,5 mm	COA-0	COA-3	COA-4	COA-5	COA-6		
	0,7 mm		COC-1	COC-2	COC-3	COC-4		
	1,0 mm	COX-9	COY-5	COY-6	COY-7	COY-8	COY-9	COY-9
			COY-1	COY-2	COY-3	COY-4		
	0,15 mm			COV-5				
	0,3 mm	COV-7	COV-1	COV-3				
	0,5 mm	COE-0	COE-1	COE-2	COE-3	COE-4		
	0,35 mm			COS-1	COS-2	COS-3	COS-4	
1x2 TEETH/ZÄHNE	0,7 mm			COX-1	COX-2	COX-3	COX-4	
	1,0 mm			COB-7	COB-1	COB-3	COB-5	COB-9
				COF-7	COF-1	COF-3	COF-5	
	2,0 mm			COB-8	COB-2	COB-4	COB-6	
				COF-8	COF-2	COF-4	COF-6	
	1,2 mm			COD-0	COD-1	COD-2	COD-3	COF-0
				COD-7	COD-4	COD-5	COD-6	
NON-TRAUMATIC ATRAUMATISCH	1,5 mm				COE-5	COD-9	COE-7	
	1,8 mm				COE-9	COE-6	COE-8	
	1,2 mm				COC-6	COD-8		
NON-TRAUMATIC ATRAUMATISCH								

 TITANIUM VERSIONS
TITAN AUSFÜHRUNGEN

CERAMO® PLANO

MICRO FORCEPS
MIKROPINZETTEN









PATTERN MODELL	LENGTH LÄNGE			
	150 mm	180 mm	210 mm	230 mm
 $\frac{1}{4}$ 1,0 mm	COG-6	COG-7	COG-8	COG-9
 $\frac{1}{4}$ 1x2 TEETH/ZÄHNE 0,7 mm	COJ-4	COJ-5	COJ-6	COJ-7
 $\frac{1}{4}$ Ø 1,0 mm		COJ-1	COJ-2	
 $\frac{1}{4}$ NON-TRAUMATIC ATRAUMATISCH 1,2 mm	COL-1 COL-5	COL-2 COL-6	COL-3 COL-7	COL-4 COL-8

 TITANIUM VERSIONS
TITAN AUSFÜHRUNGEN

CERAMO[®] PLANO-S

MICRO FORCEPS
MIKROPINZETTEN





PATTERN MODELL	LENGTH LÄNGE	200 mm	225 mm	240 mm
 0,4 mm		COT-1 COU-1	COT-7 COU-7	COT-2 COU-2
 0,9 mm		COT-3 COU-3	COT-8 COU-8	COT-4 COU-4
 1x2 TEETH/ZÄHNE 0,7 mm		COT-5 COU-5	COT-9 COU-9	COT-6 COU-6
 Ø 1,0 mm			CPA-1 COU-0	CZE-1
 Ø 2,0 mm			CPA-2 COT-0	CZE-2
 NON-TRAUMATIC ATRAUMATISCH 1,2 mm		COM-7	COM-5	COM-6

 TITANIUM VERSIONS
TITAN AUSFÜHRUNGEN



CERAMO® PLANO-S

TUMOR AND TISSUE GRASPING FORCEPS
TUMOR- UND GEWEBE-FASSPINZETTEN



PATTERN MODELL	DIAMETER DURCHM.	LENGTH / LÄNGE	
		220 mm	240 mm
	3,0 mm	COG-1 COH-1	COG-3 COH-4
	5,0 mm	COG-2 COH-2	COG-4 COH-5
	7,0 mm		COG-5 COH-6
SPOONSHAPED / LÖFFELFÖRMIG			
	3,0 mm	COP-1 COM-1	CON-7
	5,0 mm	COP-3 COM-3	CON-8
FLAT, SERRATED / FLACH, GEZAHNT			
	3,0 mm	COP-2 COM-2	
	5,0 mm	COP-4 COM-4	
CURETTESH., SERRATED / KÜRETTENF., GEZAHNT			

 TITANIUM VERSIONS
TITAN AUSFÜHRUNGEN











PATTERN MODELL	DIAMETE DURCHM.	LENGTH LÄNGE
		230 mm
	3,0 mm	CON-1 COO-1
	4,0 mm	CON-3 COO-3
	5,0 mm	CON-5 COO-5
SPOONSHAPED / LÖFFELFÖRMIG		
	3,0 mm	CON-2 COO-2
	4,0 mm	CON-4 COO-4
	5,0 mm	CON-6 COO-6
SPOONSHAPED / LÖFFELFÖRMIG		

 TITANIUM VERSIONS
TITAN AUSFÜHRUNGEN

CERAMO® RONDO

MICRO NEEDLE HOLDERS
MIKRONADELHALTER



PATTERN MODELL		LENGTH LÄNGE		120 mm	150 mm	180 mm	210 mm	230 mm	250 mm
 0,5 mm max. 9x0	WITH LOCK MIT SPERRE	KOY-1	KOD-5	KOD-9	KOE-9				
	WITHOUT LOCK OHNE SPERRE	KOY-2	KOD-6	KOE-0	KOF-0				
 0,5 mm max. 9x0	WITH LOCK MIT SPERRE	KOY-3	KOD-7	KOE-1					
	WITHOUT LOCK OHNE SPERRE	KOY-4	KOD-8	KOE-2	KOD-0				
 1,0 mm max. 7x0	WITH LOCK MIT SPERRE	KRA-1	KOA-1	KOA-3	KOA-5	KOA-7	KOA-0		
	WITHOUT LOCK OHNE SPERRE		KOA-2	KOA-4	KOA-6	KOA-8			
 1,0 mm max. 7x0	WITH LOCK MIT SPERRE		KOB-1	KOB-3	KOB-5	KOB-7			
	WITHOUT LOCK OHNE SPERRE		KOB-2	KOB-4	KOB-6	KOB-8			
 1,0 mm max. 7x0	WITH LOCK MIT SPERRE	KOL-9	KOL-1	KOL-3	KOL-5	KOL-7			
	WITHOUT LOCK OHNE SPERRE	KOL-0	KOL-2	KOL-4	KOL-6	KOL-8			
 1,5 mm max. 6x0	WITH LOCK MIT SPERRE		KOT-8	KOT-5	KOT-6	KOT-7	KOS-9		
	WITHOUT LOCK OHNE SPERRE		KOK-0	KOK-5	KOK-6	KOK-7			
 1,5 mm max. 6x0	WITH LOCK MIT SPERRE		KRB-1	KOU-9	KRB-2	KRB-3			
	WITHOUT LOCK OHNE SPERRE		KOY-8	KOY-0	KOY-9	KOZ-0			
 2,0 mm max. 5x0	WITH LOCK MIT SPERRE		KOT-2	KOD-1	KOD-3	KOT-3	KOT-0		
	WITHOUT LOCK OHNE SPERRE		KOX-9	KOD-2	KOD-4	KOT-4			
 2,0 mm max. 5x0	WITH LOCK MIT SPERRE		KOY-6	KOY-7	KOU-7	KOU-8			
	WITHOUT LOCK OHNE SPERRE		KOZ-7	KOZ-8	KOZ-6	KOZ-5			
 2,5 mm max. 3x0	WITH LOCK MIT SPERRE								KOU-5



max. needle size
max. Nadelgröße

 TITANIUM VERSIONS
TITAN AUSFÜHRUNGEN

CERAMO[®]

MICRO NEEDLE HOLDERS
MIKRONADELHALTER







PLANO						
PATTERN MODELL	LENGTH LÄNGE	150 mm	180 mm	210 mm	230 mm	250 mm
	 1,0 mm max. 7x0	WITH LOCK MIT SPERRE	KOC-3 KOM-1	KOC-4 KOM-2	KOC-7 KOM-3	KOC-5 KOM-4
WITHOUT LOCK OHNE SPERRE			KRB-0	KRA-9		
 2,0 mm max. 5x0	WITH LOCK MIT SPERRE	KOZ-1	KOZ-2	KOZ-3	KOZ-4	
	WITHOUT LOCK OHNE SPERRE		KRA-7		KRA-8	
 2,5 mm max. 3x0	WITH LOCK MIT SPERRE					KOW-0

max. needle size
max. Nadelgröße

TITANIUM VERSIONS
TITAN AUSFÜHRUNGEN



PLANO-S				
PATTERN MODELL	LENGTH LÄNGE	200 mm	225 mm	240 mm
	 0,4 mm max. 9x0		KOV-2	KOV-4
 0,4 mm max. 9x0		KOV-1	KOV-3	KOV-5
 1,0 mm max. 7x0		KON-1 KOM-3	KOM-5 KOM-6	KON-2 KOM-4
 1,0 mm max. 7x0		KOM-8	KOM-7	KON-5
 2,0 mm max. 5x0			KOM-0	KOV-7

max. needle size
max. Nadelgröße

TITANIUM VERSIONS
TITAN AUSFÜHRUNGEN

CERAMO[®]

MICRO NEEDLE HOLDERS
MIKRONADELHALTER



VAN DONGEN

PATTERN MODELL	LENGTH LÄNGE	135 mm	180 mm
	 1/4 1,0 mm max. 7x0	KOC-1	KOC-2



SYNTHESIS
200 mm
KOT-1

 1/4
 1,2 mm
 max. 7x0

CERAMO® RONDO

MICRO SCISSORS
MIKROSCHEREN



PATTERN MODELL		LENGTH LÄNGE						
		120 mm	150 mm	180 mm	210 mm	230 mm	250 mm	
	POINTED SPITZ	BSL-2	BSN-5	BSN-3			BSK-9	
	POINTED SPITZ	BSL-3	BSN-6	BSN-4				
	POINTED SPITZ		BRK-2	BRK-4	BRK-6	BRK-8		
	SERRATED GEZAHNT		BRL-2	BRL-4	BRL-6	BRL-8		
	POINTED SPITZ		BRK-1	BRK-3	BRK-5	BRK-7		
	SERRATED GEZAHNT		BRL-1	BRL-3	BRL-5	BRL-7		
	BLUNT STUMPF		BSI-1	BSI-2	BSI-3	BSI-4		
	POINTED SPITZ			BRS-3				
	BLUNT STUMPF			BRS-4				

 BLADES WITH TC-INSERT
BLÄTTER MIT TC-EINSATZ

CERAMO[®] PLANO

MICRO SCISSORS
MIKROSCHEREN







PATTERN MODELL		LENGTH LÄNGE	120 mm	150 mm	180 mm	210 mm	230 mm	250 mm
		 10 mm	POINTED SPITZ	BRV-2	BRV-4	BRV-6		
 10 mm	POINTED SPITZ	BRV-1	BRV-3	BRV-5				
 14 mm	POINTED SPITZ		BRC-2	BRC-4	BRC-6	BRC-8		
	SERRATED GEZAHNT		BRE-4	BRE-2	BRE-6	BRE-8		
 14 mm	POINTED SPITZ		BRC-1	BRC-3	BRC-5	BRC-7		
	SERRATED GEZAHNT		BRE-3	BRE-1	BRE-5	BRE-7		
 14 mm	POINTED SPITZ			BRS-1				
	BLUNT STUMPF			BRS-2				

 BLADES WITH TC-INSERT
BLÄTTER MIT TC-EINSATZ

CERAMO[®] PLANO-S



MICRO SCISSORS
MIKROSCHEREN



PATTERN MODELL		LENGTH LÄNGE	165 mm	185 mm	200 mm	225 mm	240 mm	250 mm
	STANDARD	BRF-8			BRD-8 BRD-4	BRD-6 BRD-2		BSN-2
	STRONG STARK				BRF-0	BRF-4		
	STANDARD	BRF-9			BRD-7 BRD-3	BRD-5 BRD-1		BSN-1
	STRONG STARK				BRF-3	BRF-5		
	FULL BLADE BLUNT	BSH-7			BSH-2	BSH-4	BSH-6	
	VOLLES BLATT STUMPF							
	FULL BLADE BLUNT	BSH-8			BSH-1	BSH-3	BSH-5	
	VOLLES BLATT STUMPF							

 TITANIUM VERSIONS
TITAN AUSFÜHRUNGEN





PATTERN MODELL		LENGTH LÄNGE	165 mm	185 mm	200 mm	225 mm	240 mm
	POINTED SPITZ	BSA-0	BRZ-3	BRZ-5	BRZ-7	BRZ-9	
	POINTED SPITZ	BRZ-0	BRZ-2	BRZ-4	BRZ-6	BRZ-8	
	HALFPOINTED HALBSPITZ		BSZ-1				
	HALFPOINTED HALBSPITZ		BRZ-1				



CERAMO[®]

VANNAS MICRO SCISSORS
VANNAS MIKROSCHEREN



PLANO			
PATTERN MODELL	LENGTH LÄNGE	150 mm	180 mm
	 ¼		BSF-4
 ¼		BSF-3	BSF-5









PLANO-S			
PATTERN MODELL	LENGTH LÄNGE	200 mm	225 mm
	 ¼		BSG-4
 ¼		BSG-3	BSG-1 BSF-1

 TITANIUM VERSIONS
TITAN AUSFÜHRUNGEN

CERAMO® RONDO

MICRO VASCULAR SCISSORS
MIKROGEFÄSS-SCHEREN









		LENGTH LÄNGE	BLADE LENGTH BLATTLÄNGE	
			7 mm	10 mm
 0°	POINTED SPITZ	180 mm		BSN-3
		250 mm		BSK-9
 25°	BALLPOINTED MIT KNOFF	180 mm		BSD-1
	POINTED SPITZ	180 mm	BSP-1	BSM-1
250 mm			BSL-4	
 45°	BALLPOINTED MIT KNOFF	180 mm		BSD-2
	POINTED SPITZ	180 mm	BSP-2	BSM-2
250 mm			BSL-6	
 60°	BALLPOINTED MIT KNOFF	180 mm		BSD-3
	POINTED SPITZ	180 mm	BSP-3	BSM-3
180 mm				
 90°	BALLPOINTED MIT KNOFF	170 mm		BSD-4
	POINTED SPITZ	170 mm	BSP-4	BSM-4
170 mm				
 125°	BALLPOINTED MIT KNOFF	170 mm		BSD-5
	POINTED SPITZ	170 mm	BSP-5	BSM-5
		250 mm		BSL-9
 140°	POINTED SPITZ	250 mm		BSL-0

BLADES WITH TC-INSERT
BLÄTTER MIT TC-EINSATZ

CERAMO® PLANO

MICRO VASCULAR SCISSORS
MIKROGEFÄSS-SCHEREN



		LENGTH LÄNGE	BLADE LENGTH BLATTLÄNGE	
			7 mm	10 mm
 0°	POINTED SPITZ	180 mm		BRV-6
		250 mm		BSL-7
 25°	BALLPOINTED MIT KNOPF	180 mm		BRI-1
	POINTED SPITZ	180 mm	BSM-6	BSK-1
		250 mm		BSK-6
 45°	BALLPOINTED MIT KNOPF	180 mm		BRI-2
	POINTED SPITZ	180 mm	BSM-7	BSK-2
		250 mm		BSK-7
 60°	BALLPOINTED MIT KNOPF	180 mm		BRI-3
	POINTED SPITZ	180 mm	BSM-8	BSK-3
		250 mm	BRA-7	
 90°	BALLPOINTED MIT KNOPF	170 mm		BRI-4
	POINTED SPITZ	170 mm	BSM-0	BSK-4
 125°	BALLPOINTED MIT KNOPF	170 mm		BRI-5
	POINTED SPITZ	170 mm	BSM-9	BSK-5
		250 mm		BSK-8
 140°	POINTED SPITZ	250 mm		BSL-8

BLADES WITH TC-INSERT
 BLÄTTER MIT TC-EINSATZ

CERAMO[®] PLANO

MICRO VASCULAR SCISSORS
MIKROGEFÄSS-SCHEREN



100 mm

	BLADE LENGTH BLATTLÄNGE	
	7 mm	10 mm
25° 	BRA-0	BRA-0L
45° 	BRA-6	BRA-6L
60° 	BRA-7	BRA-7L
90° 	BRA-9	BRA-9L
125° 	BRA-8	BRA-8L

ACCESSORIES
ZUBEHÖR



250 x 150 x 20 mm	UCA-4
381 x 254 x 19 mm	UCA-1

PLASTIC CONTAINER
KUNSTSTOFFCONTAINER

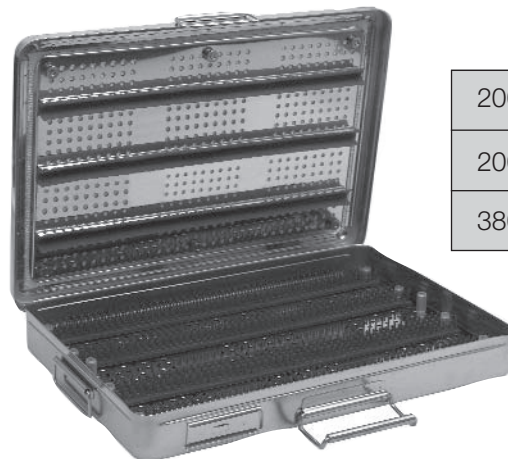

200 x 140 x 50 mm	UBL-2
200 x 140 x 65 mm	UBL-3
380 x 260 x 50 mm	UBC-8

METAL CONTAINER
METALLCONTAINER

TISSUE INLAY FOR UBC-8
TEXTILFILTER FÜR UBC-8

UBL-8

TISSUE INLAY FOR UBL-2 + UBL-3
TEXTILFILTER FÜR UBL-2 + UBL-3

UBL-0